

# Directional control valves, direct operated, with electrical position feedback and integrated electronics (OBE)

## Type HD-4WRPEH6



- ▶ Size 6
- ▶ Component series 3X
- ▶ Maximum operating pressure 350 bar
- ▶ Rated flow 4 ... 40 l/min
- ▶ Digital interface, IO link for I4.0

### Features

- ▶ Reliable - proven and robust design
- ▶ Safe - fail-safe position of the control spool in switched-off condition
- ▶ Energy-efficient - no pilot oil demand
- ▶ High quality - control spool and sleeve in servo quality
- ▶ Flexible - suitable for position, velocity and pressure control
- ▶ Precise - high response sensitivity and little hysteresis
- ▶ IO-Link interface, optional. Use of the valve with IO-Link as a shut-off element up to category 3, PL d according to EN 13849-1.

### Contents

Features	1
Ordering code	2
Symbols	3
Function, section	4, 5
Technical data	6 ... 9
Block diagram/controller function block	10
Electrical connections and assignment	11
Characteristic curves	12 ... 20
Dimensions	21, 22
Accessories	22

**Ordering code**

01	02	03	04	05	06	07	08	09	10	11	12	13	14	15	16	17
<b>HD</b>	<b>-</b>	<b>4</b>	<b>WRP</b>	<b>E</b>	<b>H</b>	<b>6</b>		<b>B</b>		<b>-</b>	<b>3X</b>	<b>/</b>	<b>/</b>	<b>24</b>		<b>*</b>

01	Huade hydraulic	<b>HD</b>
02	4 main ports	<b>4</b>
03	Directional control valve, direct operated	<b>WRP</b>
04	With integrated electronics	<b>E</b>
05	Control spool/sleeve	<b>H</b>
06	Size 6	<b>6</b>
07	Symbols; possible version see page 3	
08	Installation side of the inductive position transducer	<b>B</b>

**Nominal flow ( $\Delta p = 35$  bar per control edge)**

09		Flow characteristic		
		<b>"L"</b>	<b>"P"</b>	
	4 l/min	✓	✓ (Inflection at 20%)	<b>04</b>
	12 l/min	✓	-	<b>12</b>
	15 l/min	-	✓ (Inflection at 60%)	<b>15</b>
	24 l/min	✓	-	<b>24</b>
	25 l/min	-	✓ (Inflection at 60%)	<b>25</b>
40 l/min	✓◇	✓ (Inflection at 40%)	<b>40</b>	

**Flow characteristic**

10	Linear	<b>L ◇</b>
	Inflected characteristic curve, linear	<b>P</b>
11	Component series 30 ... 39 (30 ... 39: unchanged installation and connection dimensions)	<b>3X</b>

**Seal material** (observe compatibility of seals with hydraulic fluid used, see page 7)

12	NBR seals	<b>M ◇</b>
	FKM seals	<b>V</b>
13	<b>Without</b> damping plate	<b>no code</b>
	<b>With</b> damping plate	<b>D</b>
14	Supply voltage of the integrated electronics 24 VDC	<b>24</b>

**Interfaces of the control electronics**

15	Command value input $\pm 10$ V	<b>A1 ◇</b>
	Command value input 4 ... 20 mA	<b>F1 ◇</b>
	IO-Link interface	<b>L1 ◇</b>
	Command value $\pm 10$ mA, actual value 4 ... 20 mA, release (connector 6+PE)	<b>C6</b>
16	<b>Without</b> electronics protection membrane	<b>no code ◇</b>
	<b>With</b> electronics protection membrane	<b>-967</b>
17	Further details in the plain text	

 **Notice:** ◇ = Preferred type

### Symbols

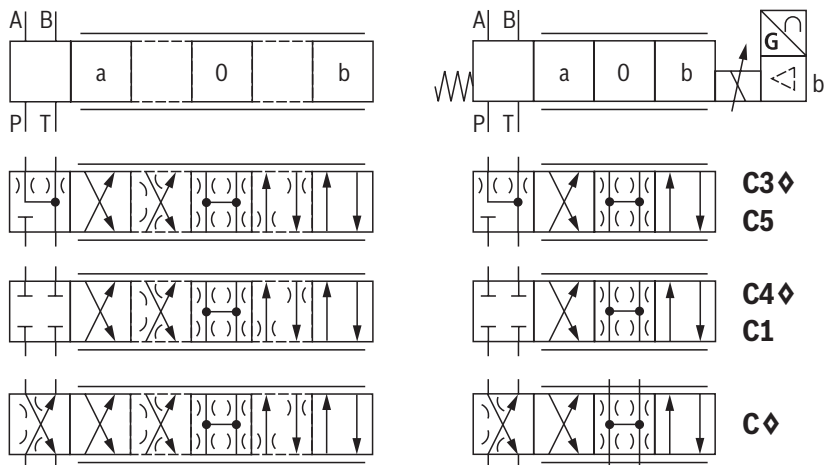

**With symbols C5 and C1:** <sup>1)</sup>  
 P → A:  $q_{V\text{ nom}}$     B → T:  $q_{V\text{ nom}}/2$   
 P → B:  $q_{V\text{ nom}}/2$     A → T:  $q_{V\text{ nom}}$

<sup>1)</sup>  $q_{V\text{ nom}}$  2:1 in connection with flow characteristic "P" only for rated flow 40 l/min (version "40")

**Notice:**  
 Representation according to DIN ISO 1219-1.  
 Hydraulic interim positions are shown by dashes.

**Notice:**  $\diamond$  = Preferred type

### Flow characteristic

Symbol	Linear characteristic curve (version "L")	Inflected characteristic curve (version "P")		
		Inflection 60% ( $q_{V\text{ nom}} = 15.25\text{ l/min}$ )	Inflection 40%	Inflection 20%
C3, C5				
C4, C1				
C				

## Function, section

Valves of type HD-4WRPEH are direct operated directional control valves with electrical position feedback and integrated electronics (OBE).

### Set-up

The HD-4WRPEH high-response valve mainly consists of:

- ▶ Valve housing with control spool and sleeve in servo quality (1)
- ▶ Control solenoid with position transducer (2) (optionally with electronics protection membrane (5))
- ▶ On-board electronics (OBE) (3) with analog or IO-Link interface (4) (optionally with damping plate (6))

### Function

The integrated electronics (OBE) compares the specified command value to the position actual value. In case of control deviations, the stroke solenoid will be activated. Due to the changed solenoid force, the control spool is adjusted against the spring. Stroke/control spool cross-section is controlled proportionally to the command value. In case of a command value presetting of 0, the electronics adjusts the control spool against the spring to central position. In deactivated condition, the spring is untensioned to a maximum and the valve is in

fail-safe position.

### Safety function (IO-Link shut-off)

By shutting off the supply voltage at the IO-Link master (Class B-Port), pins 2 and 5, the IO-Link valve can be safely switched off. After shut-off of the supply voltage, the control spool of the valve is set to fail-safe position. In order to also guarantee the hydraulic prerequisite for the safety shut-down, the overlap of control spool/sleeve must also be considered.

Sufficient overlap is guaranteed by the symbols C3, C5, C4 and C1.

The safe shut-off is not part of the IO-Link valve and must be taken into account for the safe design of the machinery.

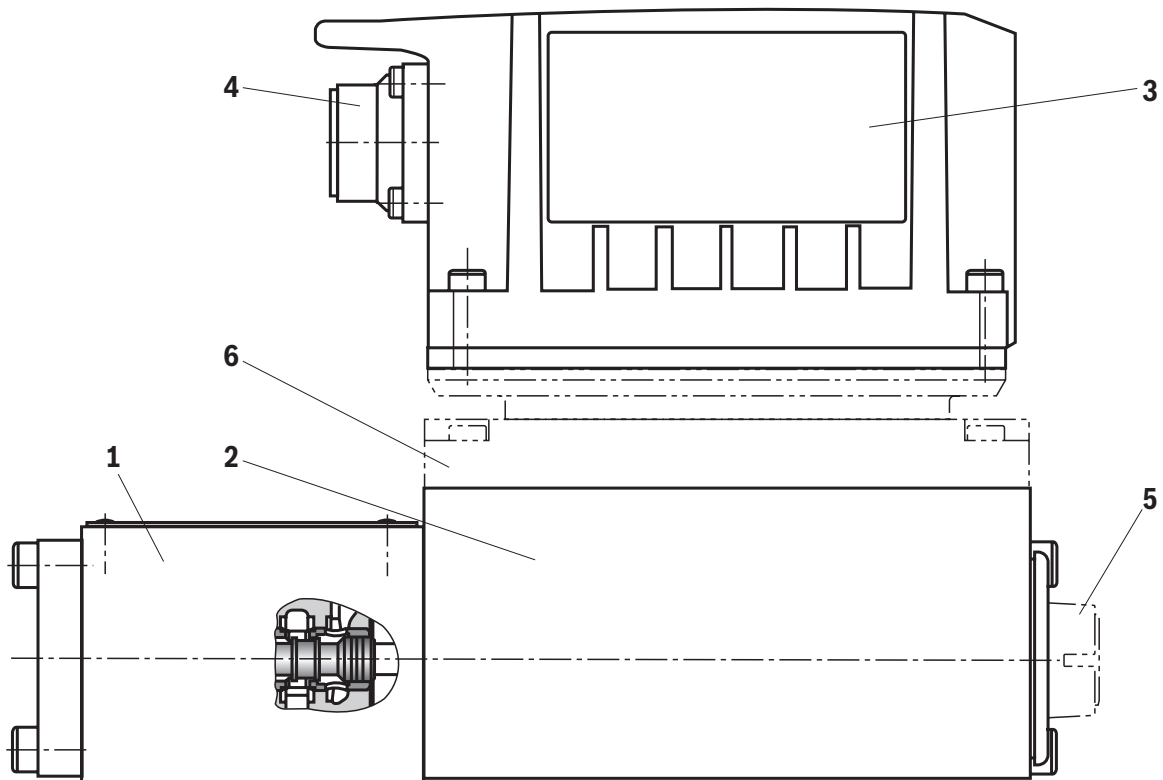

## Function, section

### Control solenoid shut-off

In case of the following errors, the control solenoids are de-energized by the integrated electronics (OBE) and the control spool is set to fail-safe position:

- ▶ Falling below the minimum supply voltage
- ▶ Only at interface "F1":
  - Falling below the minimum current command value of 2 mA (includes cable break of the command value line (current loop))
- ▶ Only at interface "L1":
  - Enable inactive, communication interruption (watchdog)
  - In case of internal IO-Link error
- ▶ Only at interface "C6":
  - Additionally, release inactive

### Damping plate "D"

The damping plate reduces the acceleration amplitudes on the on-board electronics (frequencies >300 Hz).

#### **Notice:**

Use of the damping plate is not recommended for applications with mainly low-frequency excitation <300 Hz

### Electronics protection membrane "-967"

To prevent condensate formation in the housing of the integrated electronics (OBE), an electronics protection membrane (5) can be used.

Recommended for use outside industry-standard conditions with high ambient air humidity and significant cyclic temperature changes (e.g. outdoors).

#### **Notice:**

- ▶ 4/4 directional control valves do not have a leakage-free basic locking when deactivated. Leakage must be considered when designing the drive. While the electrical supply voltage is being switched off, the drive may be accelerated for a short time in functional direction P→B.
- ▶ When using the valve with IO-Link interface in compliance with category 3 according to EN 13849-1, adequate cyclic diagnosis or monitoring of the valve function outside of the valve by the control system must be implemented by the machine integrator. Without suitable diagnostic measures, only cat. B or 1 according to EN 13849-1.

**Technical data**

(For applications outside these values, please consult us!)

General		
Type of connection	Subplate mounting	
Porting pattern	ISO 4401-03-02-0-05	
Weight	kg 2.9	
Installation position	Any	
Ambient temperature range	°C -20 ... +60	
Transport temperature	°C -30 ... +80	
Maximum storage time	Years 1	
Maximum relative humidity (no condensation)	% 95	
Protection class according to EN 60529	IP65 (if suitable and correctly mounted mating connectors are used)	
Maximum surface temperature	°C 150	
MTTF <sub>D</sub> value according to EN ISO 13849	Years 150 (for further details see data sheet 08012)	
Sine test according to DIN EN 60068-2-6	▶ Without damping plate	10 ... 2000 Hz / maximum of 10 g / 10 cycles / 3 axes
	▶ With damping plate <sup>1)</sup>	10 ... 2000 Hz / maximum of 10 g / 10 cycles / 3 axes
Noise test according to DIN EN 60068-2-64	▶ Without damping plate	20 ... 2000 Hz / 10 g <sub>RMS</sub> / 30 g peak / 30 min. / 3 axes
	▶ With damping plate <sup>1)</sup>	20 ... 2000 Hz / 10 g <sub>RMS</sub> / 30 g peak / 24 h / 3 axes
Transport shock according to DIN EN 60068-2-27	▶ Without damping plate	15 g / 11 ms / 3 shocks / 3 axes
	▶ With damping plate <sup>1)</sup>	15 g / 11 ms / 3 shocks / 3 axes
Shock according to DIN EN 60068-2-27	▶ With damping plate <sup>1)</sup>	35 g / 6 ms / 1000 shocks / 3 axes
Conformity	▶ CE according to EMC directive 2014/30/EU, tested according to	EN 61000-6-2 and EN 61000-6-3
	▶ RoHS directive	2011/65/EU <sup>2)</sup>

Hydraulic		
Maximum operating pressure	▶ Ports A, B, P	bar 350
	▶ Port T	bar 250
Hydraulic fluid		See table on page 7
Viscosity range	▶ Recommended	mm <sup>2</sup> /s 20 ... 100
	▶ Maximum admissible	mm <sup>2</sup> /s 10 ... 800
Hydraulic fluid temperature range (flown-through)	°C	-20 ... +70
Maximum admissible degree of contamination of the hydraulic fluid; cleanliness class according to ISO 4406 (c)		Class 18/16/13 <sup>3)</sup>
Rated flow ( $\Delta p = 35$ bar per control edge) <sup>4)</sup>	l/min	4      12      15      24/25      40
Limitation of use ( $\Delta p$ ) with regard to the transition to failsafe (values apply to summated edge)	▶ Symbols C3, C5, C	bar 350      350      350      350      160
	▶ Symbols C1, C4	bar 350      350      280      250      100

<sup>1)</sup> Not recommended for applications with mainly low-frequency excitation <300 Hz

<sup>2)</sup> The product fulfills the substance requirements of the RoHS directive 2011/65/EU.

<sup>3)</sup> The cleanliness classes specified for the components must be adhered to in hydraulic systems. Effective filtration prevents faults and at the same time increases the life cycle of the components.

<sup>4)</sup> Flow for deviating  $\Delta p$  (per control edge):

$$q_x = q_{Vnom} \cdot \sqrt{\frac{\Delta p_x}{35}}$$

## Technical data

(For applications outside these values, please consult us!)

Hydraulic fluid	Classification	Suitable sealing materials	Standards
Mineral oils	HL, HLP, HLPD, HVLP, HVLPD	NBR, FKM	DIN 51524
Bio-degradable	▶ Insoluble in water	HETG	ISO 15380
		HEES	
	▶ Soluble in water	HEPG	ISO 15380
Flame-resistant	▶ Water-free	HFDU (glycol base)	ISO 12922
		HFDU (ester base)	
		HFDR	
	▶ Containing water	HFC (Fuchs: Hydrotherm 46M, Fuchs Renosafe 500; Petrofer: Ultra Safe 620; Houghton: Safe 620; Union: Carbide HP5046)	NBR



### Important information on hydraulic fluids:

- ▶ For further information and data on the use of other hydraulic fluids, please refer to the data sheets above or contact us.
  - ▶ There may be limitations regarding the technical valve data (temperature, pressure range, life cycle, maintenance intervals, etc.).
  - ▶ The ignition temperature of the hydraulic fluid used must be 50 K higher than the maximum surface temperature.
  - ▶ Bio-degradable and flame-resistant – containing water: If components with galvanic zinc coating (e.g. version "J3" or "J5") or parts containing zinc are used, small amounts of dissolved zinc may get into the hydraulic system and cause accelerated aging of the hydraulic fluid. Zinc soap may form as a chemical reaction product, which may clog filters, nozzles and solenoid valves – particularly in connection with local heat input.
- ▶ Flame-resistant – containing water:
    - Due to the increased cavitation tendency with HFC hydraulic fluids, the life cycle of the component may be reduced by up to 30% as compared to the use with mineral oil HLP. In order to reduce the cavitation effect, it is recommended – if possible specific to the installation – backing up the return flow pressure in ports T to approx. 20% of the pressure differential at the component.
    - Dependent on the hydraulic fluid used, the maximum ambient and hydraulic fluid temperature must not exceed 50 °C. In order to reduce the heat input into the component, the command value profile is to be adjusted for proportional and high-response valves.

Static/dynamic		
Hysteresis	%	<0.1
Range of inversion	%	<0.05
Response sensitivity	%	<0.05
Manufacturing tolerance $q_{Vmax}$	%	<10
Temperature drift (temperature range 20 °C ... 80 °C)		Zero shift <0.25% with $\Delta t = 10$ K
Pressure drift	%/100 bar	Zero shift <0.15
Zero point calibration	%	$\pm 1$ (ex works)

**Technical data**

(For applications outside these values, please consult us!)

<b>Electrical, integrated electronics (OBE) – Interface "A1"</b>			
Supply voltage	▶ Nominal value	VDC	24
	▶ Minimum	VDC	19
	▶ Maximum	VDC	36
	▶ Maximum residual ripple	V <sub>pp</sub>	2.5
	▶ Maximum power consumption	VA	40
	▶ Fuse protection, external	A <sub>T</sub>	2.5 (time-lag)
Relative duty cycle time according to VDE 0580		%	S1 (continuous operation)
Functional ground and screening		See pin assignment on page 11 (CE-compliant installation)	
Maximum voltage of the differential inputs against 0 V		D → B; E → B (max. 18 V)	
Command value (differential amplifier)	▶ Measurement range	V	±10
	▶ Input resistance	kΩ	>100
Actual value (test signal)	▶ Output range	V	±10
	▶ Minimum load impedance	kΩ	>1

<b>Electrical, integrated electronics (OBE) – Interface "F1"</b>			
Supply voltage	▶ Nominal value	VDC	24
	▶ Minimum	VDC	19
	▶ Maximum	VDC	36
	▶ Maximum residual ripple	V <sub>pp</sub>	2.5
	▶ Maximum power consumption	VA	40
	▶ Fuse protection, external	A <sub>T</sub>	2.5 (time-lag)
Relative duty cycle time according to VDE 0580		%	S1 (continuous operation)
Functional ground and screening		See pin assignment on page 11 (CE-compliant installation)	
Maximum voltage of the differential inputs against 0 V		D → B; E → B (max. 18 V)	
Command value	▶ Input current range	mA	4 ... 20
	▶ Input resistance	kΩ	200
Actual value (test signal)	▶ Output range	mA	4 ... 20
	▶ Maximum load	Ω	500

<b>Electrical, integrated electronics (OBE) – Interface "C6"</b>			
Supply voltage	▶ Nominal value	VDC	24
	▶ Minimum	VDC	19
	▶ Maximum	VDC	36
	▶ Maximum residual ripple	V <sub>pp</sub>	2.5
	▶ Maximum power consumption	VA	40
	▶ Fuse protection, external	A <sub>T</sub>	2.5 (time-lag)
Relative duty cycle time according to VDE 0580		%	S1 (continuous operation)
Functional ground and screening		See page 11 (EMC-compliant installation)	
Command value	▶ Input current range	mA	±10
	▶ Input resistance	Ω	200
Actual value (test signal)	▶ Output range	mA	4 ... 20
	▶ Maximum load	Ω	500
Enable	▶ Low level range	V	-3 ... 5
	▶ High level range	V	11 ... $U_B$
	▶ Maximum current consumption at high level	mA	7.25 ( $U_B = 24$ V); 11 ( $U_{B \max}$ )



**Technical data**

(For applications outside these values, please consult us!)

<b>Electrical, integrated electronics (OBE) – Interface "L1"</b>		
Supply voltage	▶ Valve amplifiers	
	– Nominal value	VDC 24
	– Minimum	VDC 18
	– Maximum	VDC 30
	– Maximum residual ripple	Vpp 1.3
	– Maximum power consumption	VA 40
	▶ IO-Link interface	
	– Nominal value	VDC 24
	– Minimum	VDC 18
	– Maximum	VDC 30
	– Maximum residual ripple	Vpp 1.3
	– Maximum power consumption	VA 1.2
Relative duty cycle time according to VDE 0580	%	S1 (continuous operation)
Functional ground and screening		Provide via valve block
Bit rate COM3	kBaud (kbit/s)	230.4
Required master port class		Class B
Directive		IO-Link Interface and System Specification Version 1.1.2

### Block diagram/controller function block

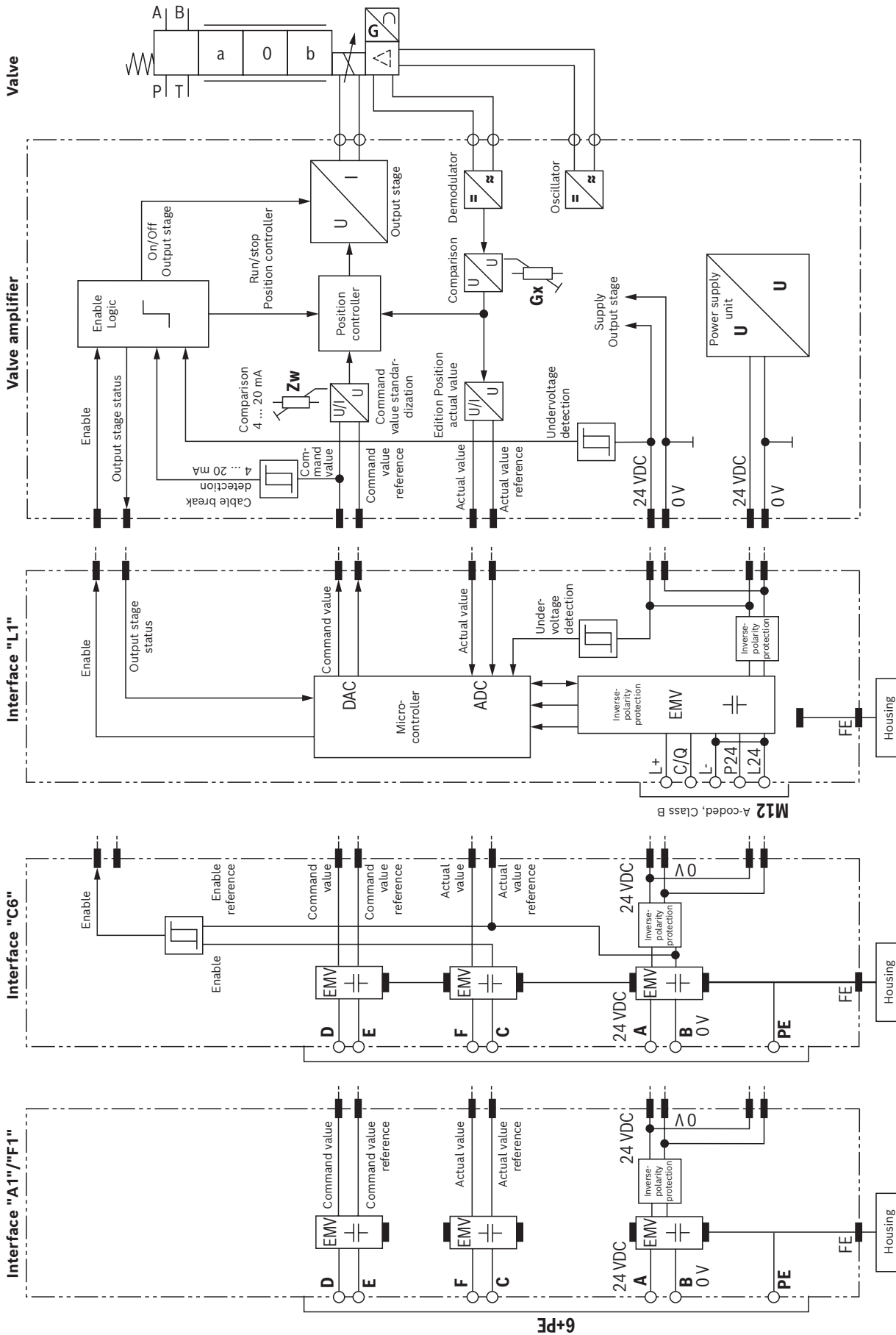

## Electrical connections and assignment

Contact	Interface assignment		
	"A1" (6 + PE)	"F1" (6 + PE)	"C6" (6 + PE)
A	Supply voltage	Supply voltage	Supply voltage
B	GND	GND	GND, reference potential actual value/enable (Current loop $I_{F-B}$ feedback)
C	Reference potential actual value	Reference potential actual value (Current loop $I_{F-C}$ feedback)	Enable input
D	Command value	Command value	Command value
E	Reference potential command value	Reference potential command value (Current loop $I_{D-E}$ feedback)	Reference potential command value (Current loop $I_{D-E}$ feedback)
F	Actual value	Actual value	Actual value
FE	Functional ground (directly connected to the valve housing)		

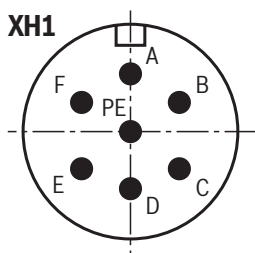

<b>Command value</b>	<ul style="list-style-type: none"> <li>▶ Positive command value (0 ... 10 V or 12 ... 20 mA) at D and reference potential at E cause flow from P → A and B → T.</li> <li>▶ Negative command value (0 ... -10 V or 12 ... 4 mA) at D and reference potential at E cause flow from P → B and A → T.</li> </ul>
<b>Connection cable</b>	<ul style="list-style-type: none"> <li>▶ Up to 20 m cable length type LiYCY 7 x 0.75 mm<sup>2</sup></li> <li>▶ Up to 40 m cable length type LiYCY 7 x 1.0 mm<sup>2</sup></li> <li>▶ EMC-compliant installation:                             <ul style="list-style-type: none"> <li>- Apply screening to both line ends</li> <li>- Use metal mating connector</li> </ul> </li> <li>▶ Alternatively up to 30 m cable length admissible                             <ul style="list-style-type: none"> <li>- Apply screening on supply side</li> <li>- Plastic mating connector can be used</li> </ul> </li> </ul>

### Connector pin assignment "L1" (M12-5, A-coded, class B)

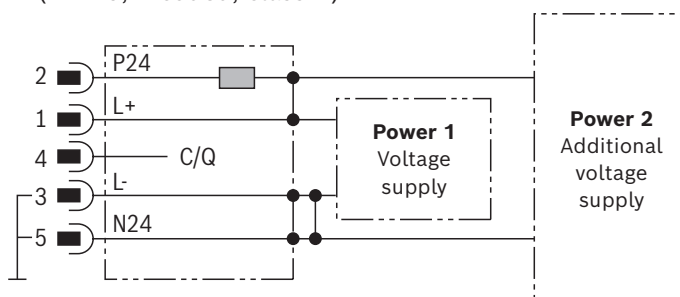
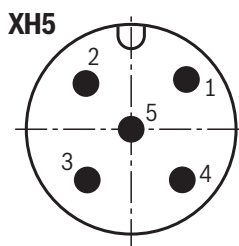

#### Notice:

- ▶ M12 sensor/actuator connection line, 5-pole; M12 connector/bush, A-coded, without shield, maximum cable length 20 m (observe the voltage drop over the cable; wire cross-section at least 0.34 mm<sup>2</sup> for a cable length of up to 5 m).

Pin	Signal	Allocation interface "L1"
1	L+	Voltage supply IO-Link
2	P24	Voltage supply valve electronics and power part (current consumption 2 A)
3	L-	Reference potential pin 1 <sup>1)</sup>
4	C/Q	Data line IO-Link (SDCI)
5	N24	Reference potential pin 2 <sup>1)</sup>

<sup>1)</sup> Pin 3 and 5 are linked with each other in the valve electronics. The reference potentials L- and N24 of the two supply voltages must also be linked with each other on the power supply unit side.

**Characteristic curves:** Flow characteristic "L"  
 (measured with HLP46,  $\vartheta_{oil} = 40 \pm 5 \text{ }^\circ\text{C}$ ;  $\Delta p = 35 \text{ bar/control edge}$ )

**Flow/signal function**

**Symbol C, C3 and C4 – Version "04"**

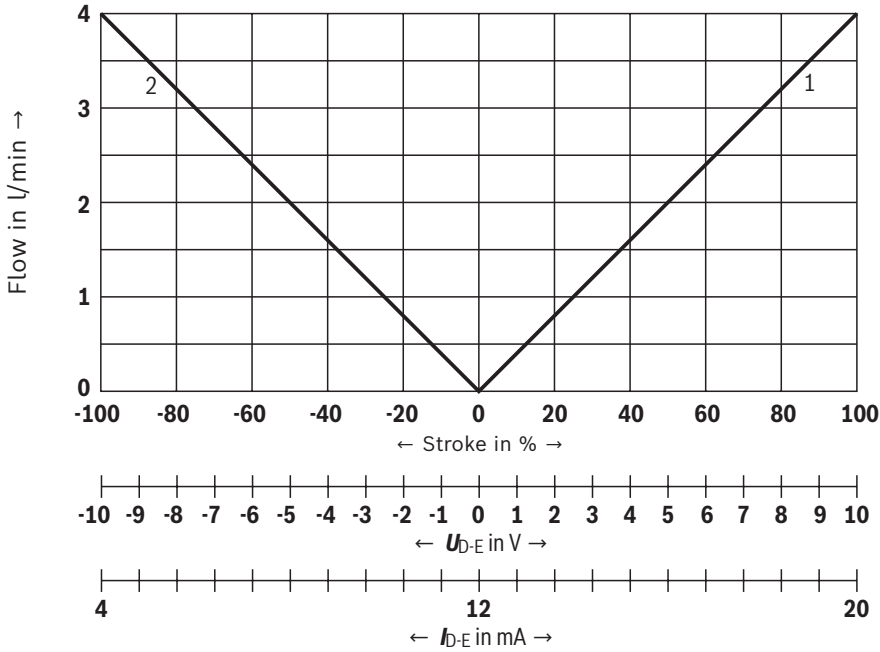

- 1 P-A; B-T
- 2 P-B; A-T

**Symbol C, C3 and C4 – Version "12"**

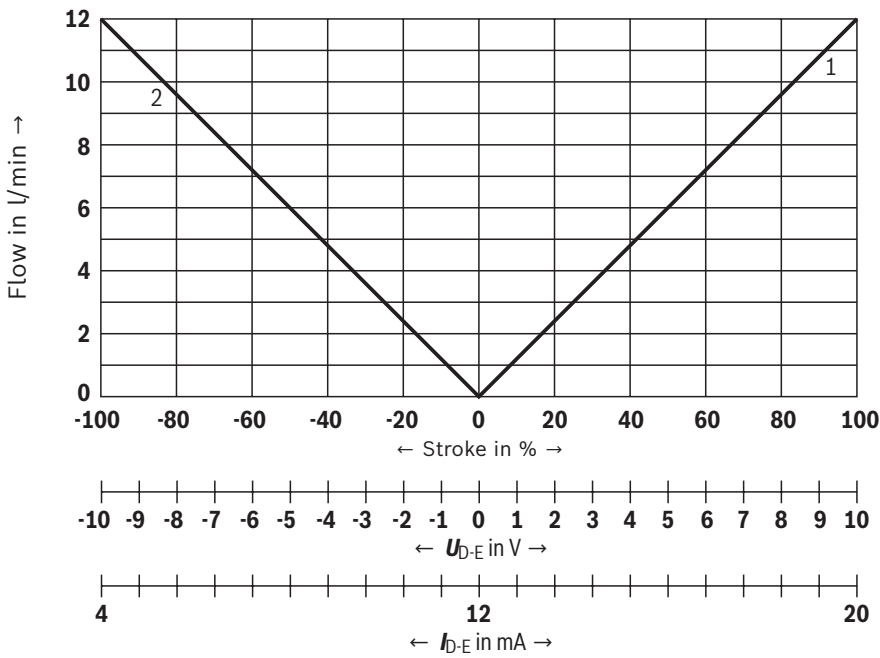

- 1 P-A; B-T
- 2 P-B; A-T

**Characteristic curves:** Flow characteristic "L"  
 (measured with HLP46,  $\vartheta_{oil} = 40 \pm 5 \text{ }^\circ\text{C}$ ;  $\Delta p = 35 \text{ bar/control edge}$ )

**Flow/signal function**

Symbol C, C3 and C4 – Version "24"

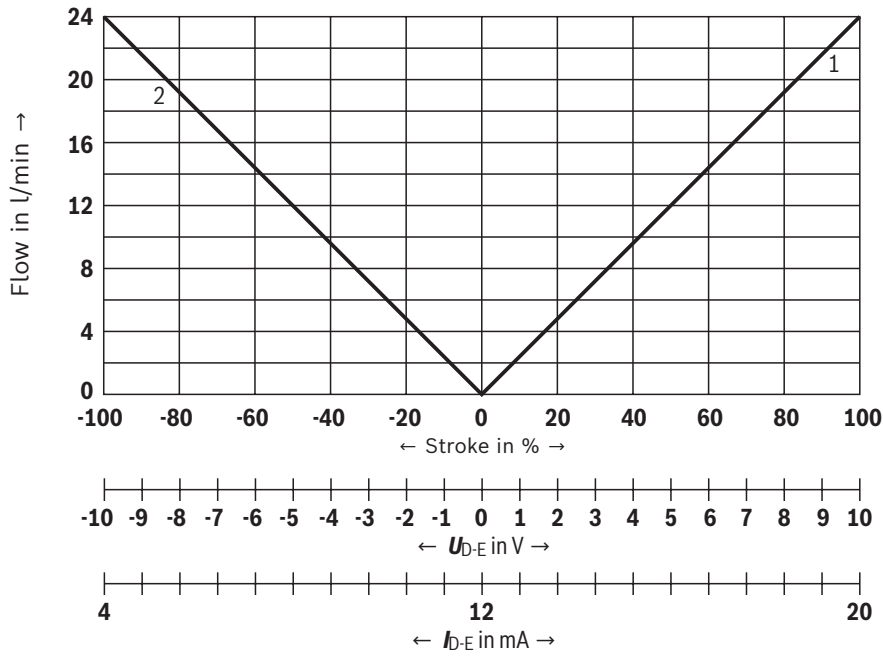

- 1 P-A; B-T
- 2 P-B; A-T

Symbol C, C3 and C4 – Version "40"

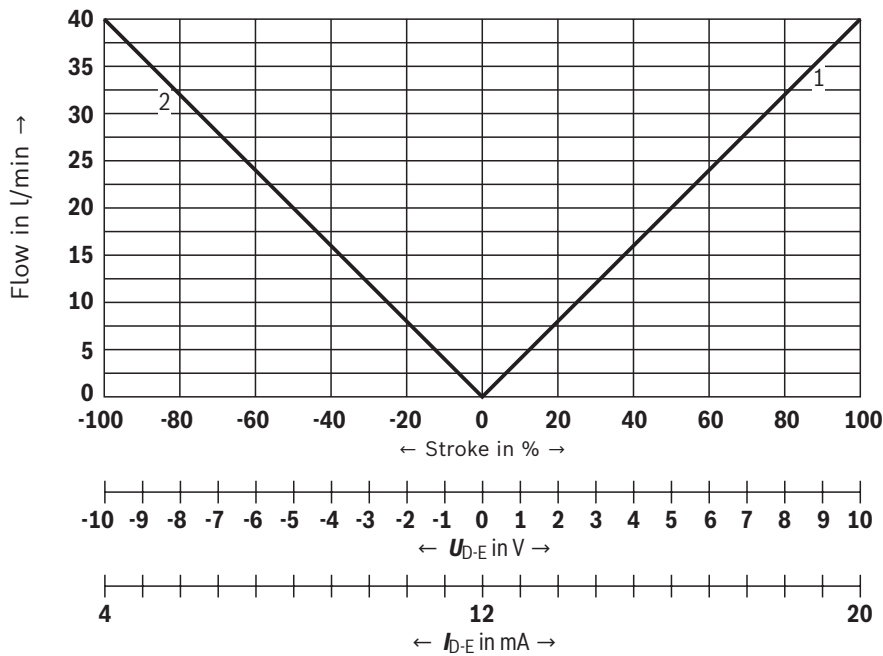

- 1 P-A; B-T
- 2 P-B; A-T

**Characteristic curves:** Flow characteristic "L"  
 (measured with HLP46,  $\vartheta_{oil} = 40 \pm 5 \text{ }^\circ\text{C}$ ;  $\Delta p = 35 \text{ bar/control edge}$ )

**Flow/signal function**

**Symbol C1 and C5 – Version "04"**

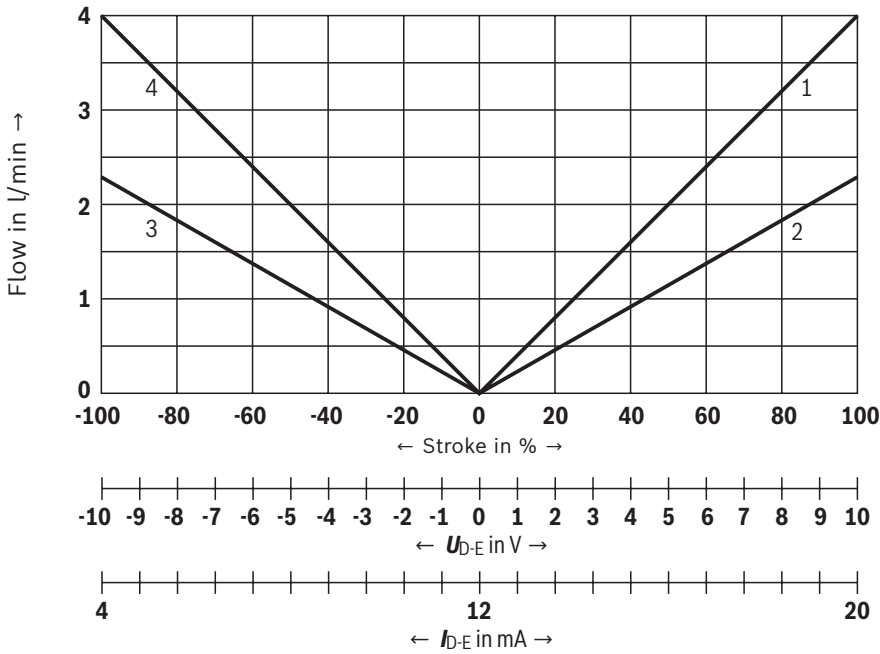

- 1 P-A
- 2 B-T
- 3 P-B
- 4 A-T

**Symbol C1 and C5 – Version "12"**

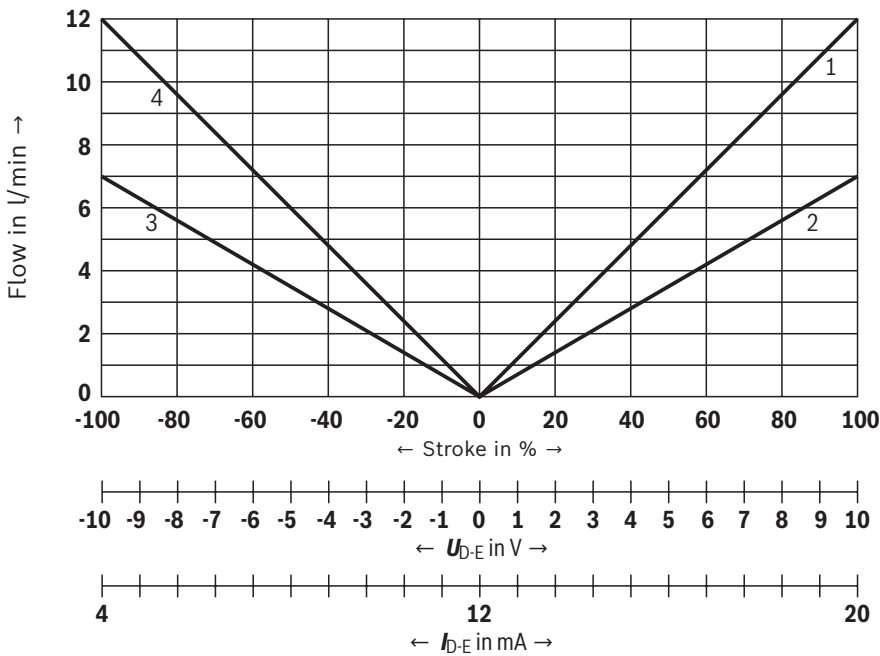

- 1 P-A
- 2 B-T
- 3 P-B
- 4 A-T

**Characteristic curves:** Flow characteristic "L"  
 (measured with HLP46,  $\vartheta_{oil} = 40 \pm 5 \text{ }^\circ\text{C}$ ;  $\Delta p = 35 \text{ bar/control edge}$ )

**Flow/signal function**

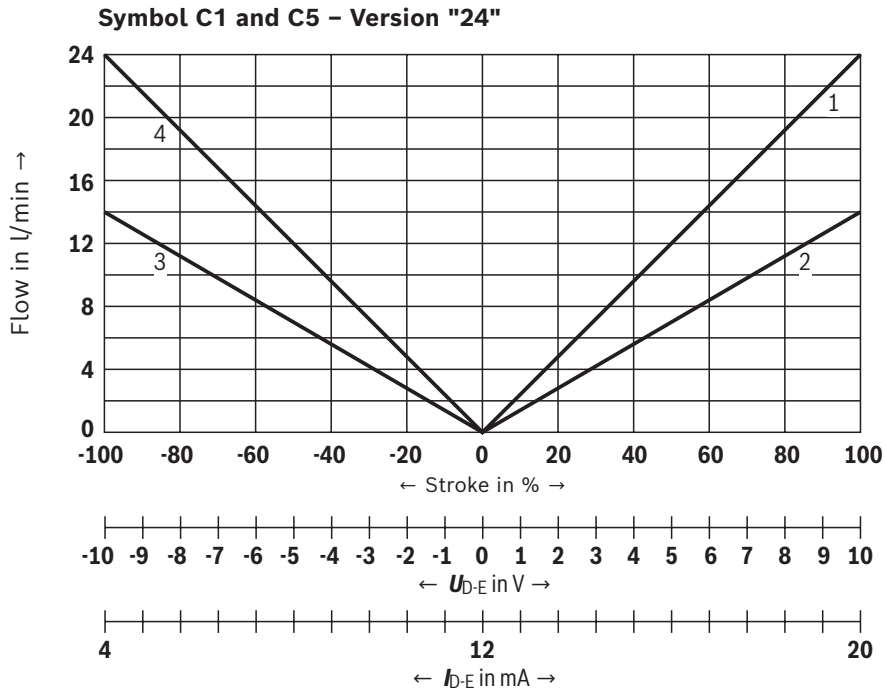

- 1 P-A
- 2 B-T
- 3 P-B
- 4 A-T

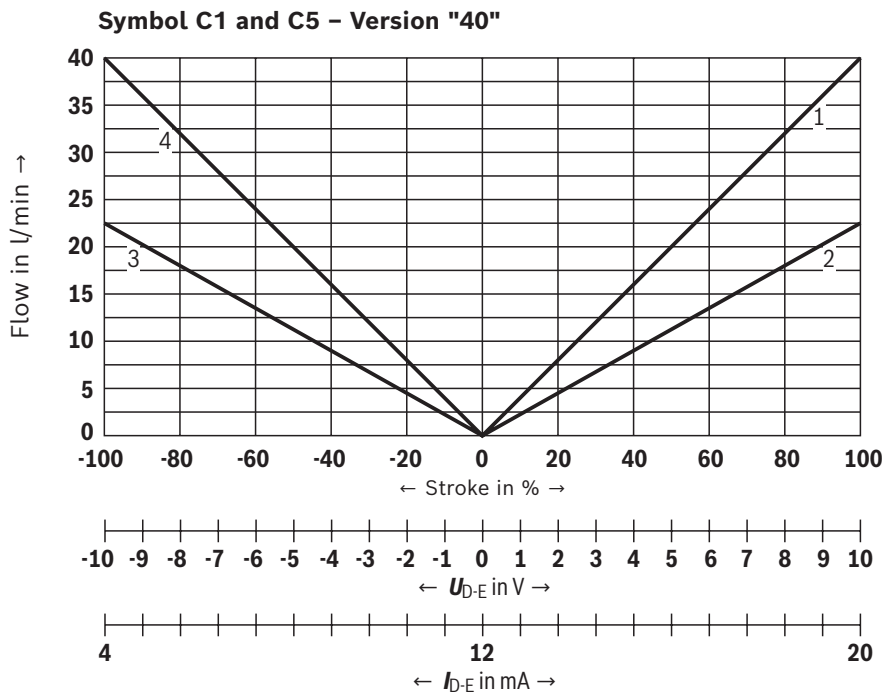

- 1 P-A
- 2 B-T
- 3 P-B
- 4 A-T

**Characteristic curves:** Flow characteristic "P"  
 (measured with HLP46,  $\vartheta_{oil} = 40 \pm 5 \text{ }^\circ\text{C}$ ;  $\Delta p = 35 \text{ bar/control edge}$ )

**Flow/signal function**

**Symbol C, C3 and C4 – Version "04"**

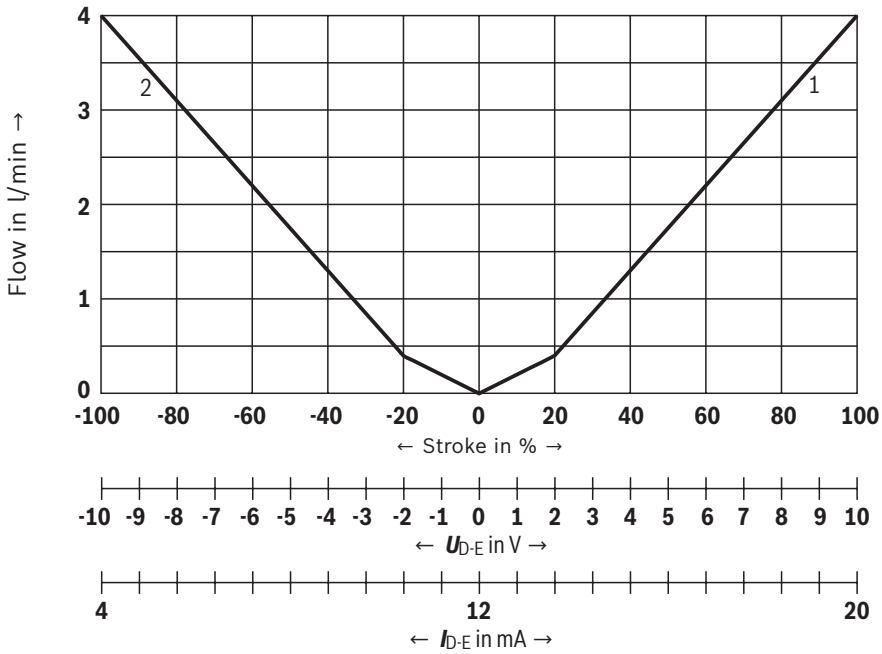

- 1 P-A; B-T
- 2 P-B; A-T

**Symbol C, C3 and C4 – Version "15"**

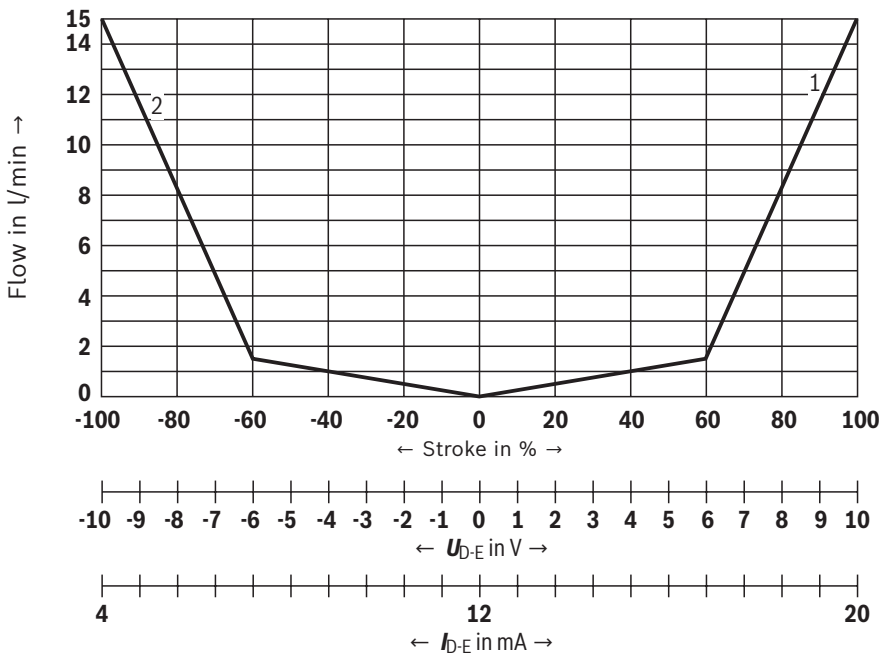

- 1 P-A; B-T
- 2 P-B; A-T



**Characteristic curves:** Flow characteristic "P"  
 (measured with HLP46,  $\vartheta_{oil} = 40 \pm 5 \text{ }^\circ\text{C}$ ;  $\Delta p = 35 \text{ bar/control edge}$ )

**Flow/signal function**

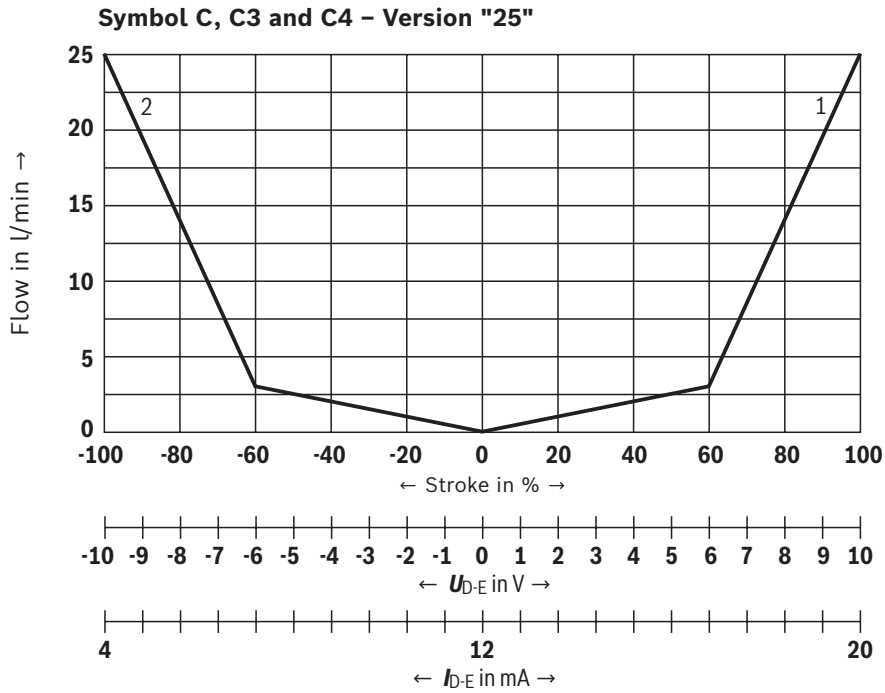

- 1 P-A; B-T
- 2 P-B; A-T

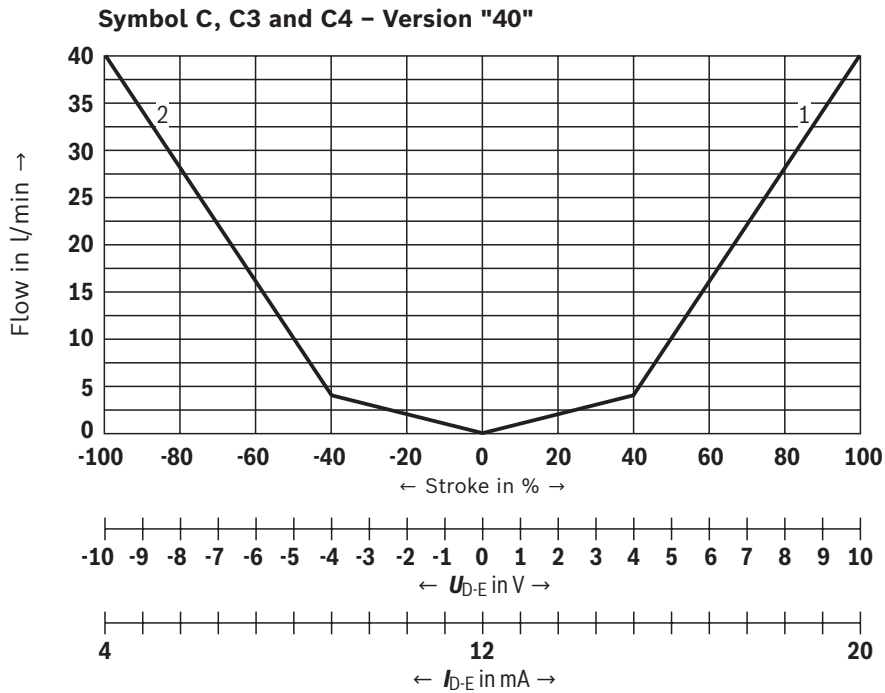

- 1 P-A; B-T
- 2 P-B; A-T

**Characteristic curves:** Flow characteristic "P"  
 (measured with HLP46,  $\vartheta_{oil} = 40 \pm 5 \text{ }^\circ\text{C}$ ;  $\Delta p = 35 \text{ bar/control edge}$ )

**Flow/signal function**

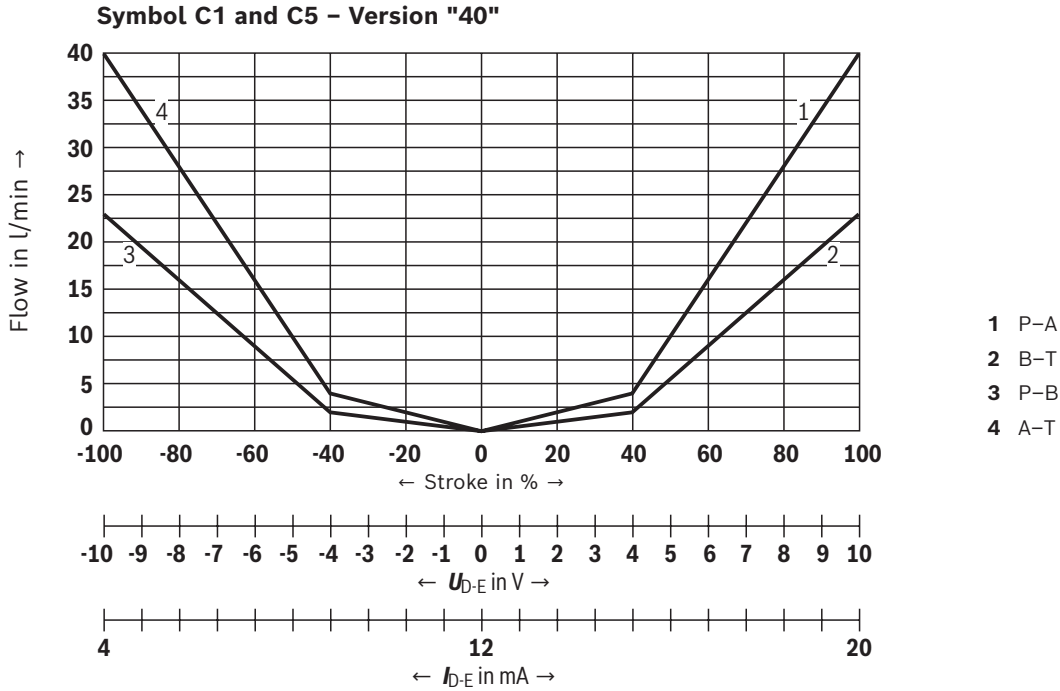

**Fail-safe position:** Flow/leakage flow

		Rated flow at $\Delta p = 35 \text{ bar/control edge}$		l/min	4	12	15	24/25	40
<b>C</b>		Flow at $\Delta p = 35 \text{ bar/control edge}$		l/min	4	10	13	18	20
		Leakage flow at 100 bar	P→A	cm <sup>3</sup> /min	50				
<b>C3, C5</b>		Flow at $\Delta p = 35 \text{ bar}$	P→B	cm <sup>3</sup> /min	70				
			A→T	l/min	10 ... 20				
<b>C4, C1</b>		Leakage flow at 100 bar	B→T	l/min	7 ... 20				
			P→A	cm <sup>3</sup> /min	50				
			P→B	cm <sup>3</sup> /min	70				
			A→T	cm <sup>3</sup> /min	70				
			B→T	cm <sup>3</sup> /min	50				
	<b>Fail-safe</b>	$p = 0 \text{ bar} \Rightarrow 7 \text{ ms}$	Internal shut-off in case of the following errors:						
		$p = 100 \text{ bar} \Rightarrow 10 \text{ ms}$	<ul style="list-style-type: none"> <li>▶ Drop of supply voltage <math>U_B \leq 15 \text{ V}</math> and restarting at <math>U_B \geq 17.5 \text{ V}</math>.</li> <li>▶ Only at interface "F1":                             <ul style="list-style-type: none"> <li>- Falling below the minimum current command value of 2 mA (includes cable break of the command value line (current loop))</li> </ul> </li> <li>▶ Only at interface "L1":                             <ul style="list-style-type: none"> <li>- Enable inactive, communication interruption (watchdog)</li> <li>- In case of internal IO-Link error</li> </ul> </li> </ul>						

### Characteristic curves

(measured with HLP46,  $\vartheta_{oil} = 40 \pm 5 \text{ }^\circ\text{C}$ )

#### Pressure/signal characteristic curve

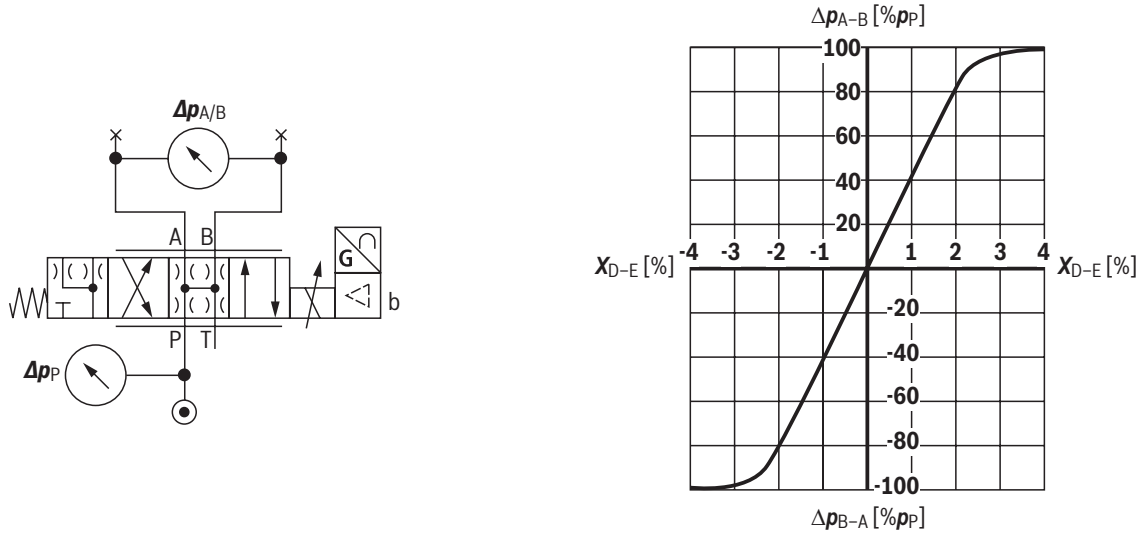

#### Transition function with stepped electric input signals

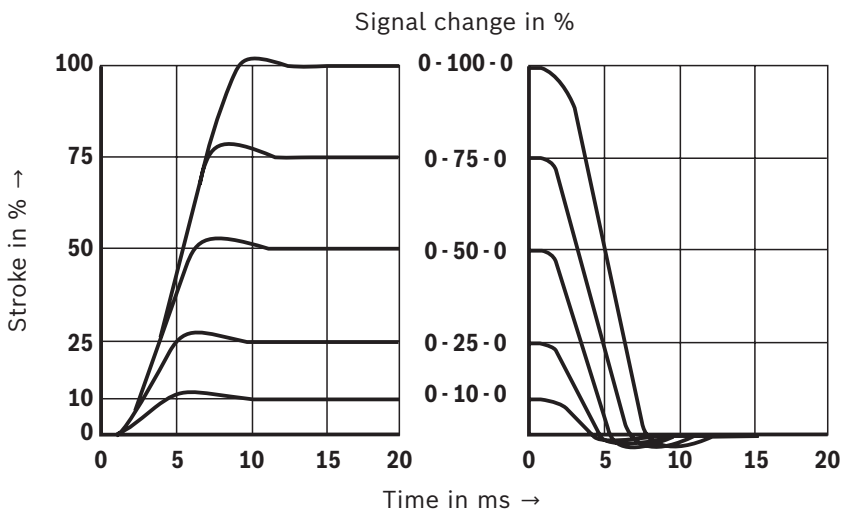

### Characteristic curves

(measured with HLP46,  $\vartheta_{oil} = 40 \pm 5 \text{ }^\circ\text{C}$ )

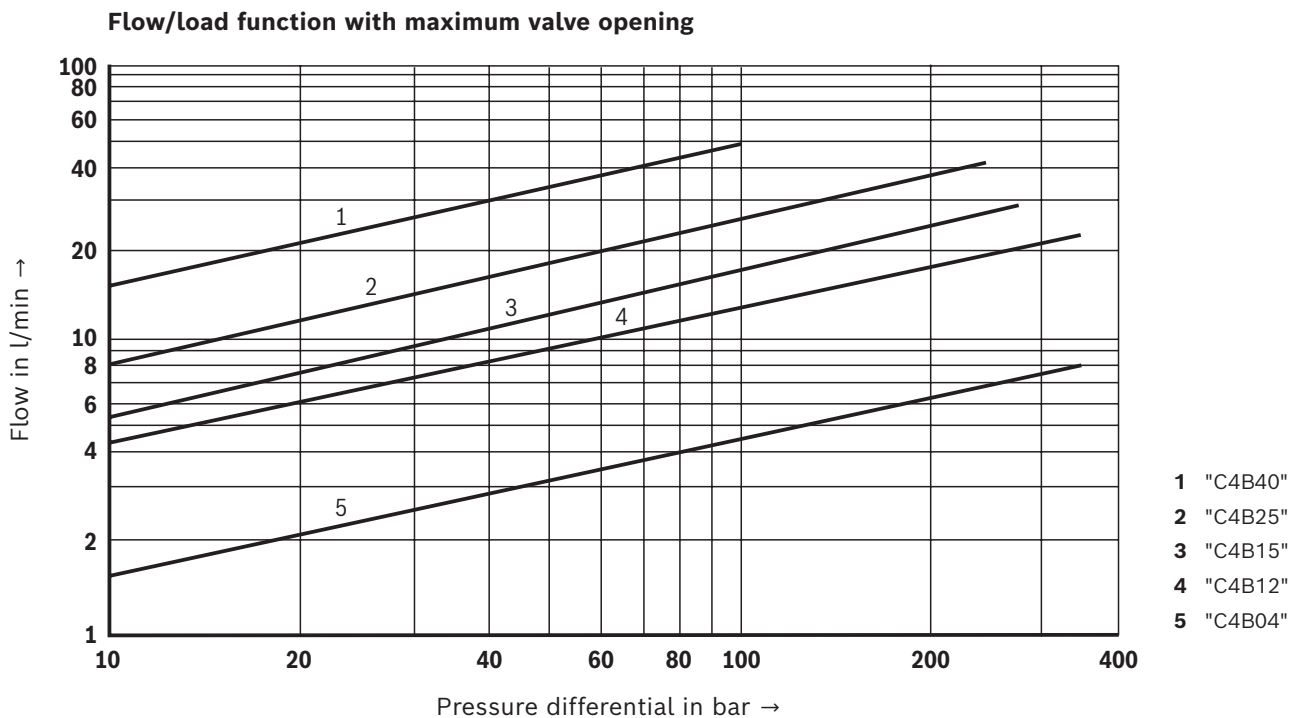
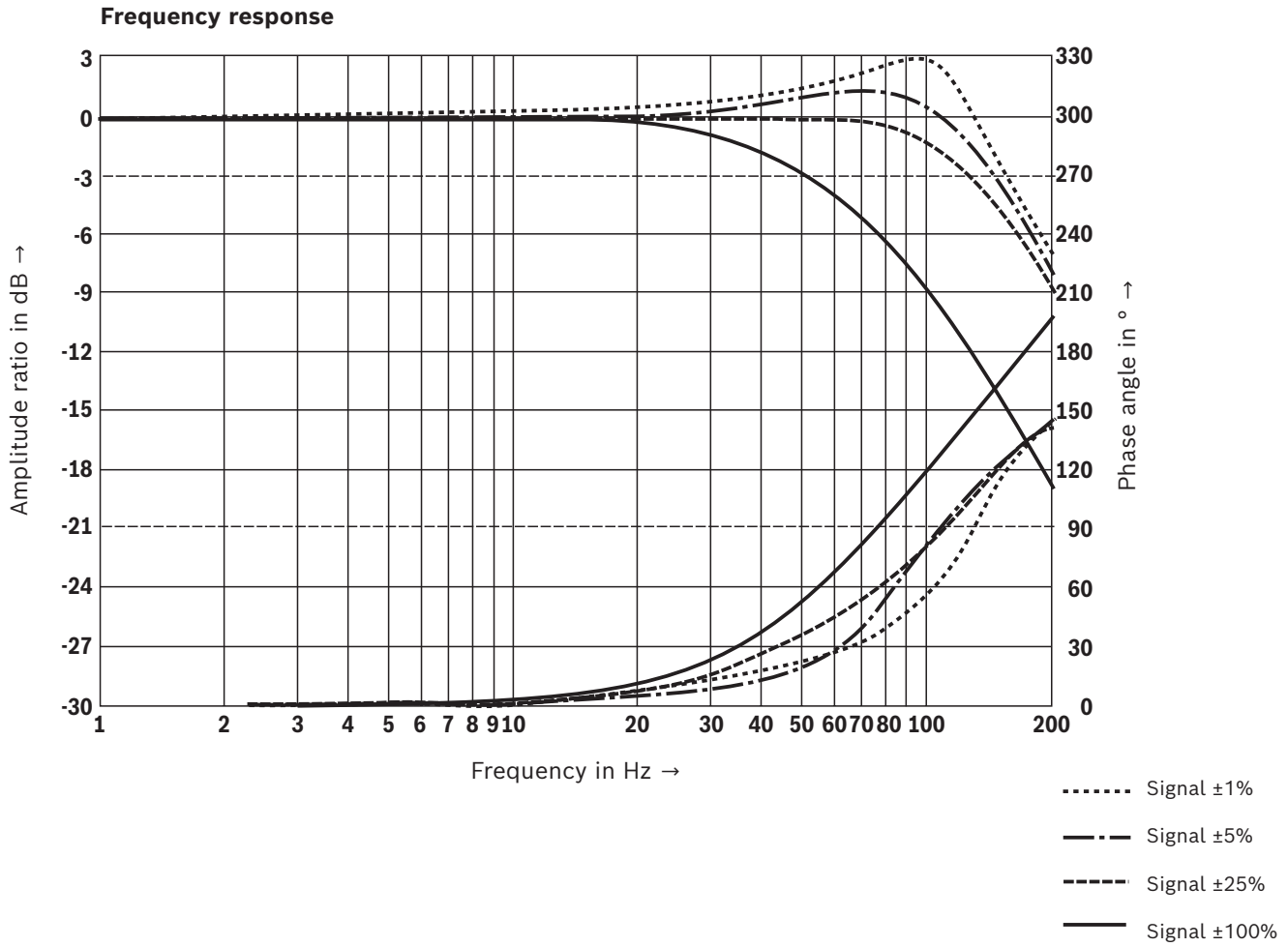

- 1 "C4B40"
- 2 "C4B25"
- 3 "C4B15"
- 4 "C4B12"
- 5 "C4B04"

## Dimensions

(dimensions in mm)

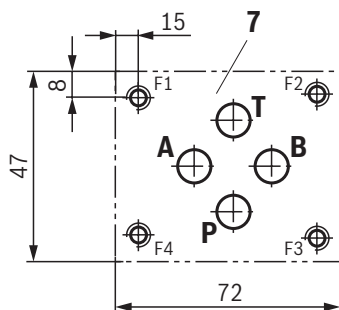
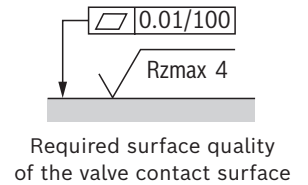
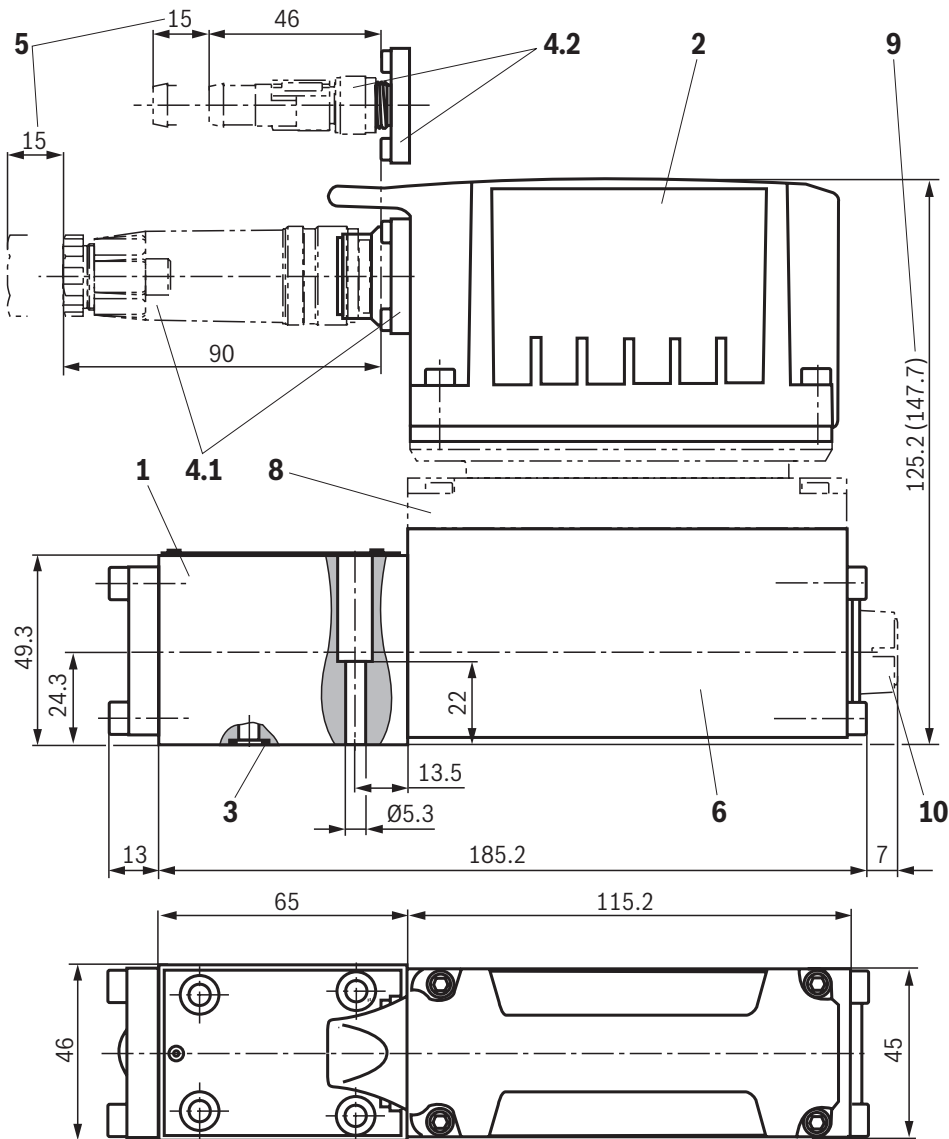

- 1 Valve housing
- 2 Integrated electronics (OBE)
- 3 Identical seal rings for ports P, A, B, T
- 4.1 Mating connectors with version "A1", "F1" and "C6", separate order.
- 4.2 Mating connectors with version "L1", separate order.
- 5 Space required for removing the mating connector
- 6 Control solenoid with position transducer
- 7 Machined valve contact surface, porting pattern according to ISO 4401-03-02-0-05  
Deviating from the standard: Ports P, A, B, T Ø8 mm  
Minimum screw-in depth:
  - ▶ Ferrous metal 1.5 x Ø
  - ▶ Non-ferrous 2 x Ø
- 8 Damping plate "D"
- 9 Dimension in ( ) for version with damping plate "D"
- 10 Electronics protection membrane "-967"

### Notice:

The dimensions are nominal dimensions which are subject to tolerances.

## Dimensions

### Valve mounting screws (separate order)

#### 4 hexagon socket head cap screws

**ISO 4762 - M5 x 30 - 10.9-CM-Fe-ZnNi-5-Cn-T0-H-B**

Tightening torque  $M_A = 7 \text{ Nm} \pm 10\%$

or

**ISO 4762 - M5 x 30 - 10.9**

Tightening torque  $M_A = 8.9 \text{ Nm} \pm 10\%$



#### Notice:

The tightening torque of the hexagon socket head cap screws refers to the maximum operating pressure.

## Accessories (separate order)

### Valves with integrated electronics

Mating connectors 6-pole + PE	Design	Version
For the connection of valves with integrated electronics, round connector 6+PE, line cross-section 0.5 ... 1.5 mm <sup>2</sup>	Straight	Metal
	Straight	Plastic
	Angled	Plastic

Cable sets 6-pole + PE	Length in m
For the connection of valves with integrated electronics, round connector 6+PE, straight connector, shielded, potted-in mating connector, line cross-section 0.75 mm <sup>2</sup>	3.0
	5.0
	10.0
	20.0

### Valves with integrated electronics and IO-Link interface

Cable sets for IO-Link	Length in m
For the connection of valves with IO-Link interface, M12-5, A-coded, unshielded, line cross-section 5 x 0.34 mm <sup>2</sup>	1.5
	3.0
	5.0